

6

5

4

3

2

1

## REVISION

ZONE	REV	DESCRIPTION	DATE	CHANGED BY	APPROVED
	A	INITIAL RELEASE	11/6/2024	DMAY	DGUTTADAURO

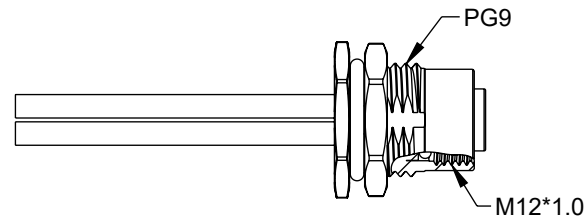
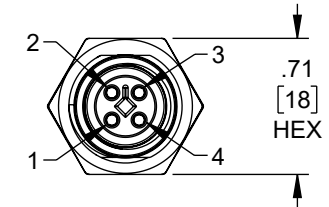
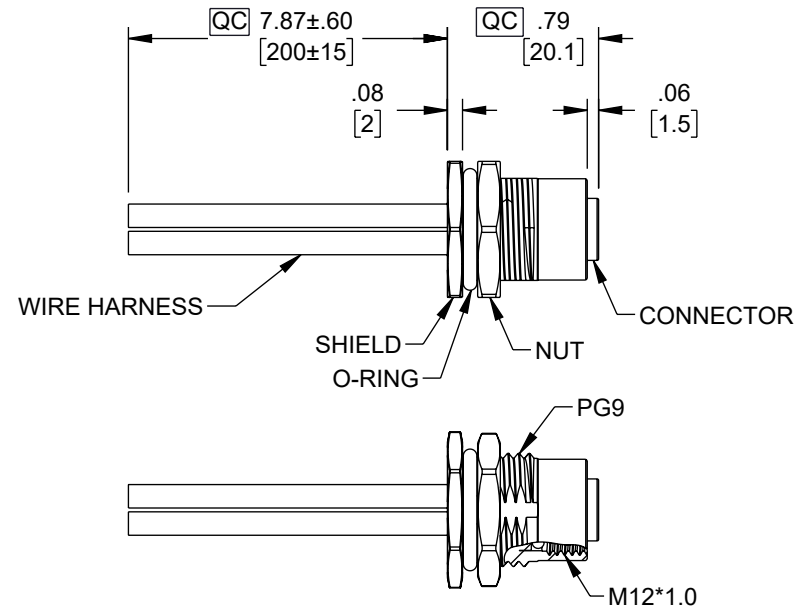
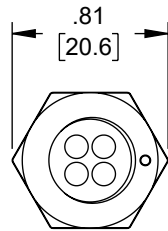

## NOTES:

1. **QC** IMPORTANT DIMENSION.
2. WATERPROOF RATE: IP68, UNMATED 1m/24h  
IP69K, MATED
3. CONNECTOR:
  1. HOUSING: THERMOPLASTIC, BLACK
  2. PIN: COPPER ALLOY, GOLD PLATED
  3. O-RING: RUBBER, GREEN
4. SHIELD: METAL
5. NUT: METAL
6. O-RING: RUBBER, BLACK
7. WIRE HARNESS: UL1015, 16AWG
8. FOR PANEL THICKNESS MAX: 4.5mm
9. O-RING AND NUT ARE ASSEMBLED ON CONNECTORS
10. TEMPERATURE RANGE: -20°C TO +85°C
11. OPERATING VOLTAGE: 63V
12. NOMINAL CURRENT: 12A

PIN OUT	
PIN#	WIRE
1	BROWN
2	WHITE
3	BLUE
4	BLACK

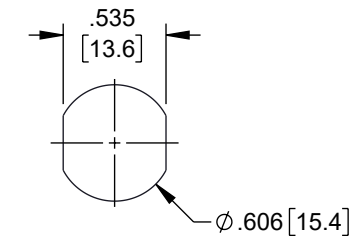

RECOMMENDED  
PANEL CUT-OUT

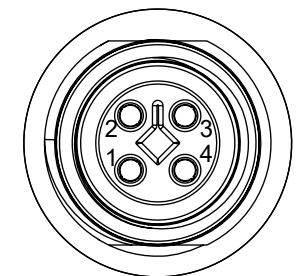

4P  
PIN ASSIGNMENTS  
FRONT VIEW

REGULATORY COMPLIANCE:  
EU RoHS DIRECTIVE (MOST RECENT RELEASED VERSION).

THE INFORMATION CONTAINED IN THIS DRAWING IS THE SOLE PROPERTY OF INFINITE ELECTRONICS, INC. ANY REPRODUCTION IN PART OR WHOLE WITHOUT THE WRITTEN PERMISSION OF INFINITE ELECTRONICS, INC. IS PROHIBITED. THESE COMMODITIES, TECHNOLOGY OR SOFTWARE WERE EXPORTED FROM THE UNITED STATES IN ACCORDANCE WITH THE EXPORT ADMINISTRATION REGULATIONS. DIVERSION CONTRARY TO U.S. LAW PROHIBITED.

UNLESS OTHERWISE SPECIFIED  
LEADING DIMENSIONS ARE INCHES  
DIMENSIONS IN [ ] ARE MILLIMETERS

TOLERANCES:  
X = ±.2 [5]      FRACTIONS  
.XX = ±.02 [0.5]      ± 1/32  
.XXX = ±.005 [0.13]      ANGLES ± 1°

CABLE LENGTH TOLERANCES:  
≤12 [305] = +1 [25] / -0  
>12 [305] ≤ 60 [1524] = +2 [51] / -0  
>60 [1524] ≤ 120 [3048] = +4 [102] / -0  
>120 [3048] ≤ 300 [7620] = +6 [152] / -0  
>300 [7620] = +5% / -0

ALL DIMENSIONS ARE FOR REFERENCE ONLY  
AND SUBJECT TO CHANGE WITHOUT NOTICE.  
UN-DIMENSIONED/NON-CRITICAL FEATURES  
MAY VARY IN SIZE AND LOCATION  
COLORS MAY VARY

**L-com**  
an INFINIT® brand

Website: www.L-com.com  
Phone: 1.800.341.5266 | 1.978.682.6936

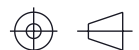

INTERPRET ALL DIMENSIONS AND  
TOLERANCES PER ASME Y14.5

SCALE	SHEET
NONE	1 OF 1

DESCRIPTION  
M12 DC POWER 4 PIN T CODE FEMALE RECEPTACLE, IP68  
IP69K RATED, 63V, 12A, PG9 FRONT PANEL MOUNT STYLE  
WITH 16AWG UL1015 PVC 0.2M LEADS

SIZE	CAGE CODE	DRAWN BY	ITEM NO.	REV
A	43321	DMAY	REC-M124TF-PG9F-L	A

6

5

4

3

2

1