

REVISIONS			
REV	DESCRIPTION	DATE	APPROVED
B	ECN 10065; ADDED VENT TUBE, DIM WAS 16 mm	08/27/19	TOZA

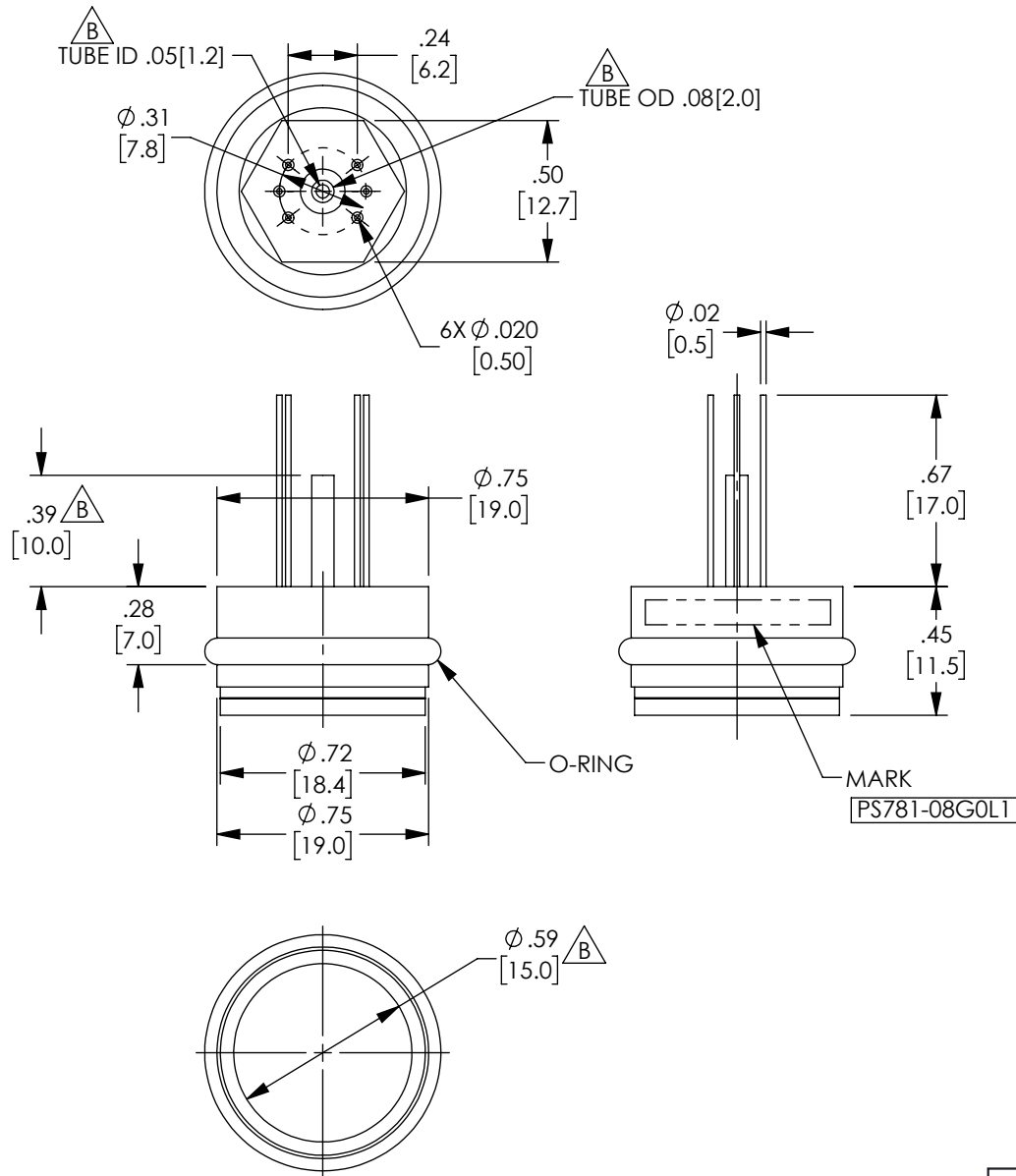

THESE COMMODITIES, TECHNOLOGY OR SOFTWARE WERE EXPORTED FROM THE UNITED STATES IN ACCORDANCE WITH THE EXPORT ADMINISTRATION REGULATIONS. DIVERSION CONTRARY TO U.S. LAW PROHIBITED.

UNLESS OTHERWISE SPECIFIED LEADING DIMENSIONS ARE INCHES DIMENSIONS IN [] ARE MILLIMETERS		 an INFINITI brand 50 High Street, West Mill, 3rd Floor, Suite #30 North Andover, MA 01845 USA. Phone: 1.800.341.5266 1.978.682.6936 Fax: 1.978.689.9484 e-mail: CustomerService@L-com.com		THE INFORMATION AND DESIGN IN THIS DOCUMENT IS THE PROPERTY OF L-COM GLOBAL CONNECTIVITY. ALL RIGHTS RESERVED.	
TOLERANCES: .X=± .2 [5.08] FRACTIONS ± 1/32 .XX=± .01 [.25] ANGLES ± 1° .XXX=± .005 [.13]				SHEET 1 OF 1	
ALL DIMENSIONS SHOWN ARE FOR REFERENCE ONLY.		SCALE N/A			
THIRD-ANGLE PROJECTION		SIZE A	CAGE 43321	DRAWN BY DZINN	PART NUMBER PS781-08G0L1
					REV B