

REVISIONS			
REV	DESCRIPTION	DATE	APPROVED
A	INITIAL RELEASE	05/22/2019	TOZA

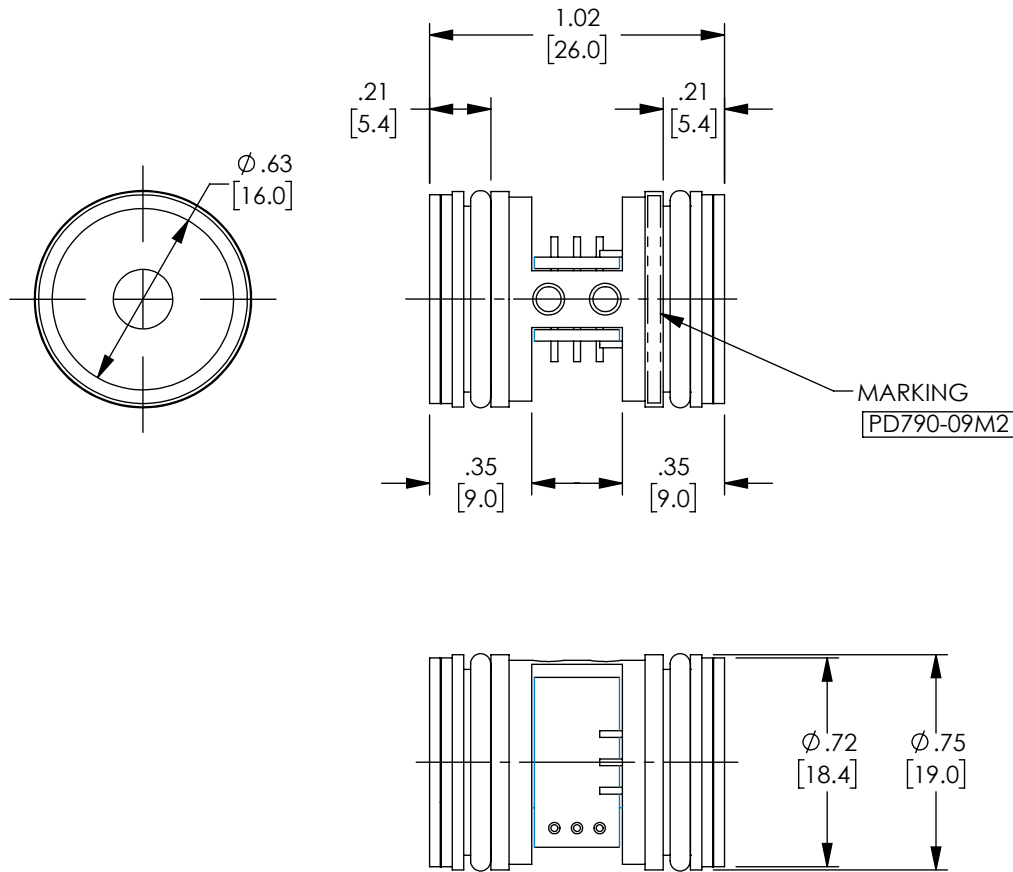

UNLESS OTHERWISE SPECIFIED LEADING DIMENSIONS ARE INCHES DIMENSIONS IN [] ARE MILLIMETERS	
TOLERANCES:	
X \pm .2 [5.08]	FRACTIONS $\pm 1/32$
.XX \pm .01 [.25]	ANGLES $\pm 1^\circ$
.XXX \pm .005 [.13]	
ALL DIMENSIONS SHOWN ARE FOR REFERENCE ONLY.	
THIRD-ANGLE PROJECTION	

L-com
an INFINITI brand
50 High Street, West Mill, 3rd Floor, Suite #30
North Andover, MA 01845 USA
Phone: 1.800.341.5266 | 1.978.682.6936
Fax: 1.978.689.9484
www.L-com.com | e-mail: CustomerService@L-com.com

SIZE	CAGE	DRAWN BY	PART NUMBER
A	43321	DZINN	PD790-09M2

THE INFORMATION AND DESIGN IN THIS DOCUMENT IS THE PROPERTY OF L-COM GLOBAL CONNECTIVITY. ALL RIGHTS RESERVED.	
SHEET	OF
1	1
SCALE	N/A
REV	A

THESE COMMODITIES, TECHNOLOGY OR SOFTWARE WERE EXPORTED FROM THE UNITED STATES IN ACCORDANCE WITH THE EXPORT ADMINISTRATION REGULATIONS. DIVERSION CONTRARY TO U.S. LAW PROHIBITED.