

THE INFORMATION CONTAINED IN THIS DRAWING IS THE SOLE PROPERTY OF L-COM, INC. ANY REPRODUCTION IN PART OR WHOLE WITHOUT THE WRITTEN PERMISSION OF L-COM, INC. IS PROHIBITED.

REVISION					
ZONE	REV	DESCRIPTION	DATE	CHANGED BY	APPROVED
	A	INITIAL RELEASE	08/15/2023	DZINN	PHOSPODAR

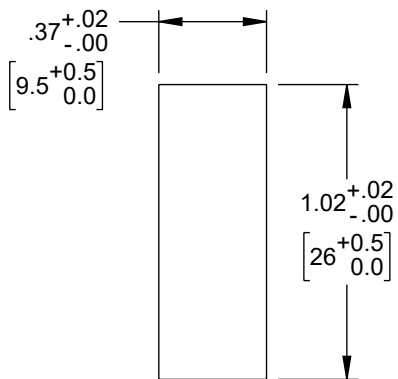

MTG HOLE
1.7mm MAX THK
REF ONLY

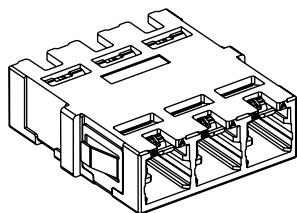
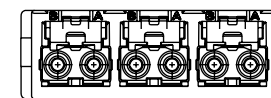
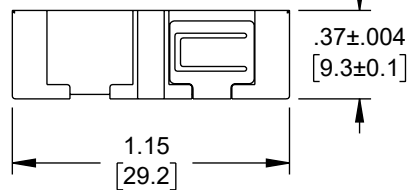
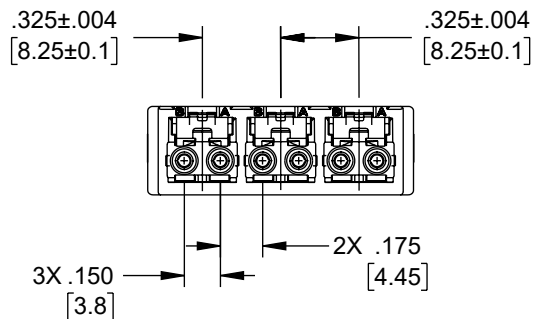
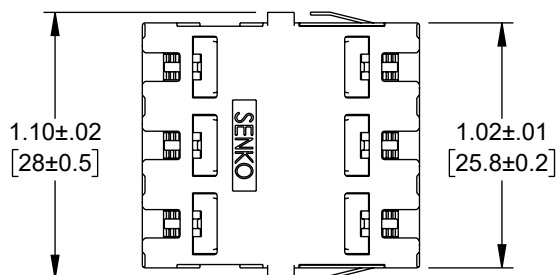

NOTES:

- ADAPTER SUPPLIED WITH 6 DUST CAPS INSTALLED WHICH ARE NOT SHOWN.
- ADAPTER SHALL BE INDIVIDUALLY PACKAGED IAW L-COM SPECIFICATION PS-0031.

REGULATORY COMPLIANCE:
EU RoHS DIRECTIVE (MOST RECENT RELEASED VERSION)

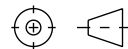
UNLESS OTHERWISE SPECIFIED, DIMENSIONS ARE IN INCHES [mm] OVERALL CABLE LENGTH TOLERANCE: ≤12 [305] = +1 [25] / -0 >12 [305] ≤60 [1524] = +2 [51] / -0 >60 [1524] ≤120 [3048] = +4 [102] / -0 >120 [3048] ≤300 [7620] = +6 [152] / -0 >300 [7620] = +5% / -0 ALL OTHER DIMENSIONAL TOLERANCES: .X = ±.2 [5] FRACTIONS ± 1/32 .XX = ±.02 [5] ANGLES ± 1° .XXX = ±.005 [1.3]	APPROVALS	DATE	 50 High Street, West Mill, North Andover, MA 01845 USA. Phone: 1.800.341.5266 1.978.682.6936			
	DRAWN BY DZINN CHECKED BY KGLEBOVA APPROVED BY JJOHNSTON	08/15/2023 08/15/2023 08/15/2023		CATEGORY		
THIRD-ANGLE PROJECTION 	CONFIGURATION DETAILS OF UNDIMENSIONED FEATURES MAY VARY COLOR VARIATIONS MAY OCCUR	PRODUCT DESCRIPTION CS TRIPLE CHANNEL (6F) ADAPTER, NO FLANGE, BLUE	SIZE A SCALE: NONE	CAGE CODE 43321 CAD FILE: FOA-CS3-01.SLDDRW	ITEM NO. FOA-CS3-01	REV. A SHEET 1 OF 1