

THE INFORMATION CONTAINED IN THIS DRAWING IS THE SOLE PROPERTY OF L-COM, INC. ANY REPRODUCTION IN PART OR WHOLE WITHOUT THE WRITTEN PERMISSION OF L-COM, INC. IS PROHIBITED.

REVISIONS			
REV	DESCRIPTION	DATE	APPROVED
A	INITIAL RELEASE	08/12/2022	GUTTADAURO

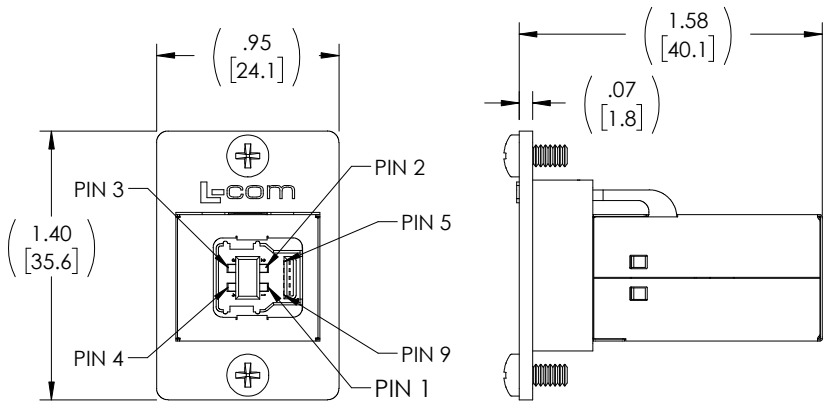

"J1"
USB 3.0 TYPE "B"
FEMALE CONNECTOR
30u" GOLD PLATED CONTACTS
NICKEL PLATED SHELL

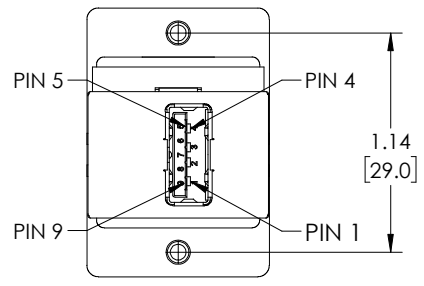

"J2"
USB 3.0 TYPE "A"
FEMALE CONNECTOR
30u" GOLD PLATED CONTACTS
NICKEL PLATED SHELL

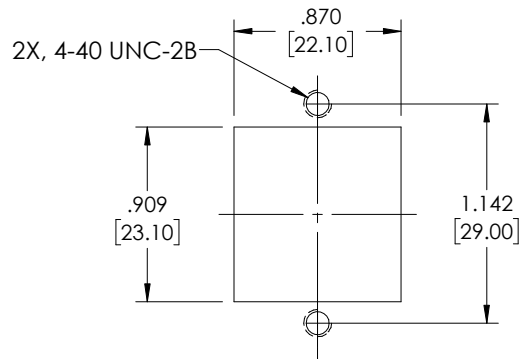
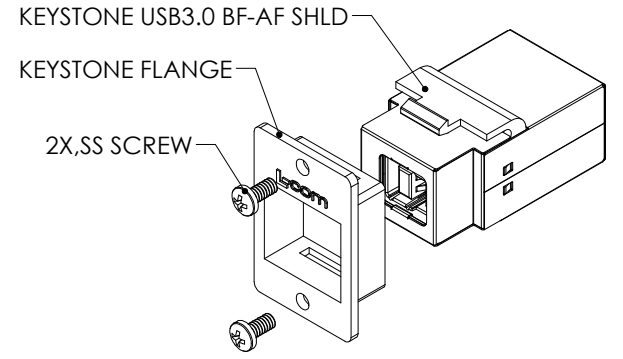

RECOMMENDED
PANEL CUTOUT

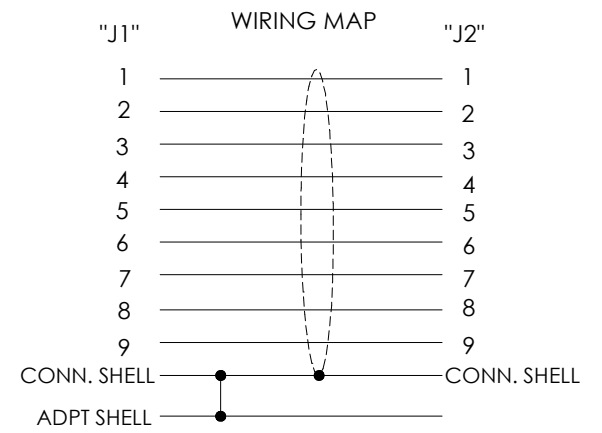

NOTES:

- ADAPTER HOUSING: ABS, UL94V-0 RATED, BLACK
ADAPTER SHIELDING: STAINLESS STEEL
ADAPTER PCB: GLASS FIBER EPOXY; FR-4,UL94 V-0
KEYSTONE FLANGE: ZINC ALLOY; NICKEL PLATED
- KIT INCLUDES (KIT SHOWN FULLY ASSEMBLED FOR CLARITY):
1-KEYSTONE USB3.0 BF-AF SHIELDED
1-ZINC ALLOY KEYSTONE FLANGE
2-#4-40 UNC-2A x 1/4 LG STAINLESS STEEL SCREW
- RATING:
CURRENT: 1.8A (P1 and P4 CONTACT); 0.25A (OTHER CONTACT)
OPERATING TEMPERATURE: -10°C TO +70°C.
- ADAPTER SHALL BE TESTED FOR CONTINUITY.
- ADAPTER KIT IS SHIPPED UN-ASSEMBLED AND SHALL BE PACKAGED IN ACCORDANCE WITH L-COM SPECIFICATION PS-0031.

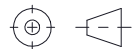
UNLESS OTHERWISE SPECIFIED, DIMENSIONS ARE IN INCHES [mm] OVERALL CABLE LENGTH TOLERANCE: ≤12 [305] = +1 [25] / -0 >12 [305] ≤60 [1524] = +2 [51] / -0 >60 [1524] ≤120 [3048] = +4 [102] / -0 >120 [3048] ≤300 [7620] = +6 [152] / -0 >300 [7620] = +5% / -0 ALL OTHER DIMENSIONAL TOLERANCES: .X = ± .2 [5] FRACTIONS ± 1/32 .XX = ± .02 [.5] ANGLES ± 1° .XXX = ± .005 [.13]	APPROVALS	DATE	 50 High Street, West Mill, North Andover, MA 01845 USA. Phone: 1.800.341.5266 1.978.682.6936
	DRAWN BY B.ZHANG	01/18/2022	
THIRD-ANGLE PROJECTION 	CHECKED BY GUTTADAURO	01/18/2022	CATEGORY USB
	APPROVED BY GUTTADAURO	01/18/2022	
CONFIGURATION DETAILS OF UNDIMENSIONED FEATURES MAY VARY	PRODUCT DESCRIPTION FLANGED PNL MNT ADPT KIT, USB3.0 BF-AF, SHLD		SIZE A
COLOR VARIATIONS MAY OCCUR	CAGE CODE 43321	DWG. NO. ECFU3KEY-BA-S	
SCALE: NONE		CAD FILE: ECFU3KEY-BA-S.SLDDRW	SHEET 1 OF 1