

THE INFORMATION CONTAINED IN THIS DRAWING IS THE SOLE PROPERTY OF L-COM, INC. ANY REPRODUCTION IN PART OR WHOLE WITHOUT THE WRITTEN PERMISSION OF L-COM, INC. IS PROHIBITED.

REVISIONS			
REV	DESCRIPTION	DATE	APPROVED
A	INITIAL RELEASE	08/12/2022	GUTTADAURO

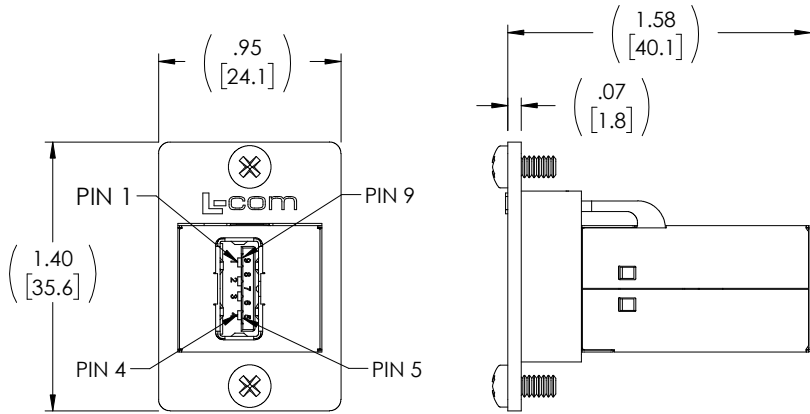

"J1"
USB 3.0 TYPE "A"
FEMALE CONNECTOR
30u" GOLD PLATED CONTACTS
NICKEL PLATED SHELL

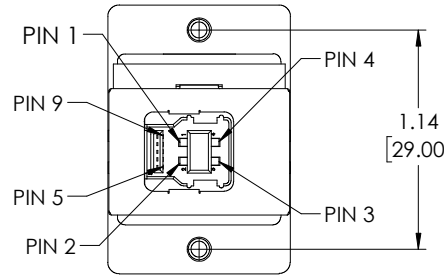

"J2"
USB 3.0 TYPE "B"
FEMALE CONNECTOR
30u" GOLD PLATED CONTACTS
NICKEL PLATED SHELL

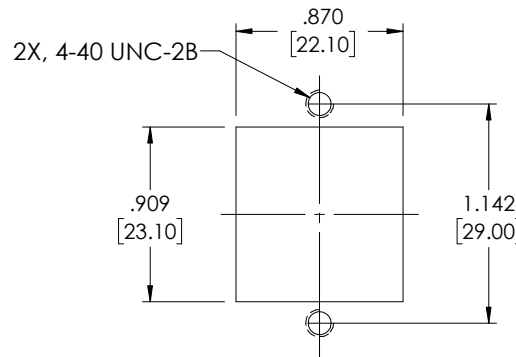
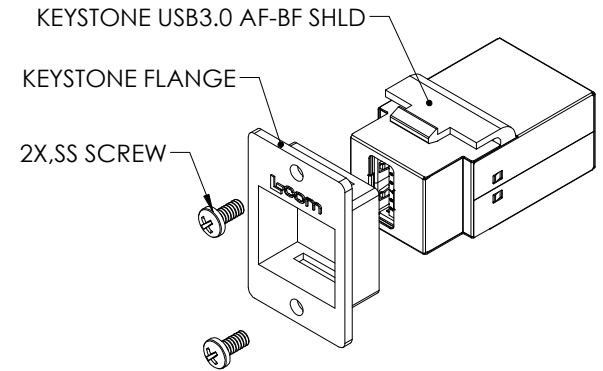

RECOMMENDED
PANEL CUTOUT

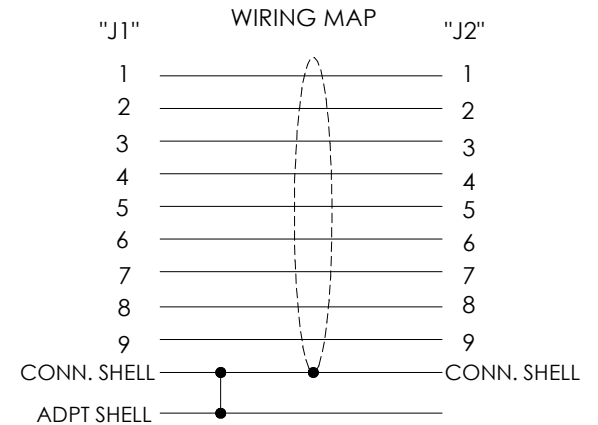

NOTES:

- ADAPTER HOUSING: ABS, UL94V-0 RATED, BLACK
ADAPTER SHIELDING: STAINLESS STEEL
ADAPTER PCB: GLASS FIBER EPOXY; FR-4, UL94 V-0
KEYSTONE FLANGE: ZINC ALLOY; NICKEL PLATED
- KIT INCLUDES (KIT SHOWN FULLY ASSEMBLED FOR CLARITY):
1-KEYSTONE USB3.0 AF-BF SHIELDED
1-ZINC ALLOY KEYSTONE FLANGE
2-#4-40 UNC-2A x 1/4 LG STAINLESS STEEL SCREW
- RATING:
CURRENT: 1.8A (P1 and P4 CONTACT); 0.25A (OTHER CONTACT)
OPERATING TEMPERATURE: -10°C TO +70°C.
- ADAPTER SHALL BE TESTED FOR CONTINUITY.
- ADAPTER KIT IS SHIPPED UN-ASSEMBLED AND SHALL BE PACKAGED IN ACCORDANCE WITH L-COM SPECIFICATION PS-0031.

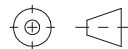
UNLESS OTHERWISE SPECIFIED, DIMENSIONS ARE IN INCHES [mm]	APPROVALS	DATE	 50 High Street, West Mill, North Andover, MA 01845 USA. Phone: 1.800.341.5266 1.978.682.6936
	DRAWN BY B.ZHANG	01/18/2022	
OVERALL CABLE LENGTH TOLERANCE: ≤12 [305] = +1 [25] / -0 >12 [305] ≤60 [1524] = +2 [51] / -0 >60 [1524] ≤120 [3048] = +4 [102] / -0 >120 [3048] ≤300 [7620] = +6 [152] / -0 >300 [7620] = +5% / -0	CHECKED BY GUTTADAURO	01/18/2022	CATEGORY USB
ALL OTHER DIMENSIONAL TOLERANCES: .X = ± .2 [5] FRACTIONS ± 1/32 .XX = ± .02 [.5] ANGLES ± 1° .XXX = ± .005 [.13]	APPROVED BY GUTTADAURO	01/18/2022	
THIRD-ANGLE PROJECTION 	CONFIGURATION DETAILS OF UNDIMENSIONED FEATURES MAY VARY	PRODUCT DESCRIPTION FLANGED PNL MNT ADPT KIT, USB3.0 AF-BF, SHLD	SIZE A
COLOR VARIATIONS MAY OCCUR	SCALE: NONE	CAGE CODE 43321	DWG. NO. ECFU3KEY-AB-S
		CAD FILE: ECFU3KEY-AB-S.SLDDRW	REV. A
			SHEET 1 OF 1