

THE INFORMATION CONTAINED IN THIS DRAWING IS THE SOLE PROPERTY OF L-COM, INC. ANY REPRODUCTION IN PART OR WHOLE WITHOUT THE WRITTEN PERMISSION OF L-COM, INC. IS PROHIBITED.

REVISIONS			
REV	DESCRIPTION	DATE	APPROVED
A	INITIAL RELEASE	10/01/2020	PHOSPODAR

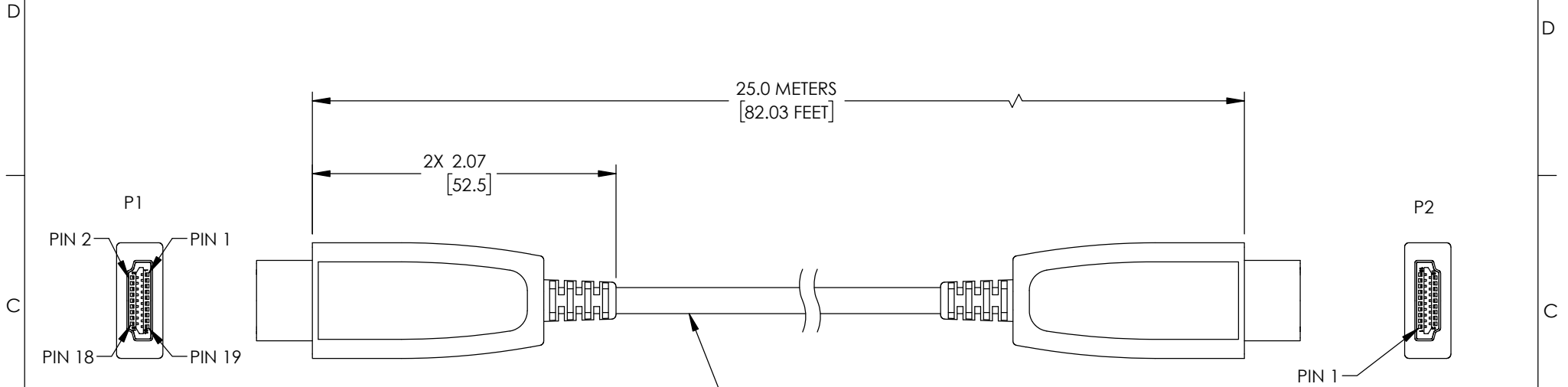

HYBRID TYPE CABLE WITH 50/125 OM3 FIBER AND COPPER CONDUCTORS.
ALUM/POLY FOIL SHIELD AND DRAIN WIRE JACKET: PVC, BLACK (O.D.: .177 [4.5])

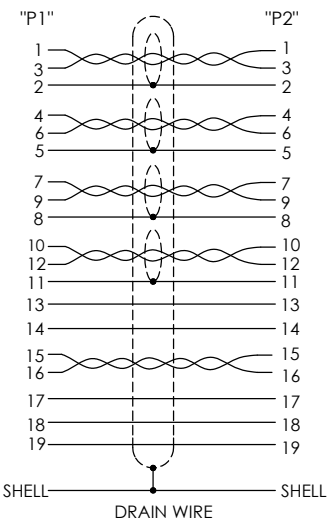

WIRE MAP



2X HDMI TYPE A MALE CONNECTOR

NOTES:

- CABLE ASSEMBLY SHALL BE TESTED FOR CONTINUITY.
- CABLE ASSEMBLY SHALL BE INDIVIDUALLY PACKAGED IN ACCORDANCE WITH L-COM SPECIFICATION PS-0031.

UNLESS OTHERWISE SPECIFIED, DIMENSIONS ARE IN INCHES [mm] OVERALL CABLE LENGTH TOLERANCE: ≤12 [305] = +1 [25] / -0 >12 [305] ≤60 [1524] = +2 [51] / -0 >60 [1524] ≤120 [3048] = +4 [102] / -0 >120 [3048] ≤300 [7620] = +6 [152] / -0 >300 [7620] = +5% / -0 ALL OTHER DIMENSIONAL TOLERANCES: .X = ±.2 [5] FRACTIONS ± 1/32 .XX = ±.02 [.5] ANGLES ± 1° .XXX = ±.005 [.13]	APPROVALS	DATE	 50 High Street, West Mill, North Andover, MA 01845 USA. Phone: 1.800.341.5266 1.978.682.6936
	DRAWN BY DFRISIELLO	10/01/2020	
APPROVED BY PHOSPODAR	10/01/2020	CATEGORY FIBER OPTICS	
THIRD-ANGLE PROJECTION 	CONFIGURATION DETAILS OF UNDIMENSIONED FEATURES MAY VARY	PRODUCT DESCRIPTION HDMI 2.0 Type A to Type A Active Optical Cable	
COLOR VARIATIONS MAY OCCUR	SIZE A	CAGE CODE 43321	ITEM NO. AOC-HDAA-20-025
SCALE: NONE		CAD FILE: AOC-HDAA-20-025.SLDDRW	
SHEET 1 OF 1			REV. A