

THE INFORMATION CONTAINED IN THIS DRAWING IS THE SOLE PROPERTY OF L-COM, INC. ANY REPRODUCTION IN PART OR WHOLE WITHOUT THE WRITTEN PERMISSION OF L-COM, INC. IS PROHIBITED.

REVISIONS			
REV	DESCRIPTION	DATE	APPROVED
A	INITIAL RELEASE	10/01/2020	PHOSPODAR

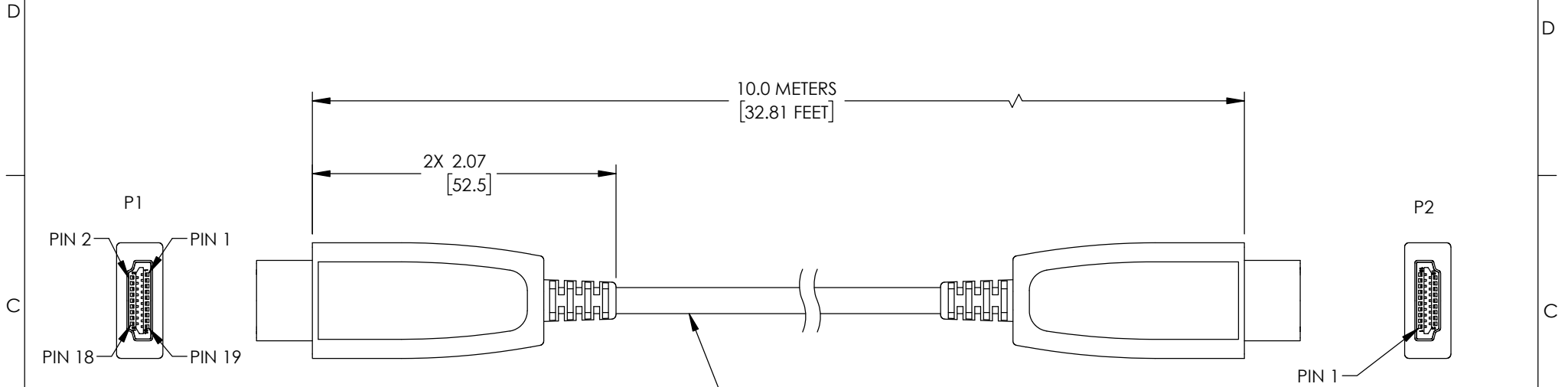

HYBRID TYPE CABLE WITH 50/125 OM3 FIBER AND COPPER CONDUCTORS. ALUM/POLY FOIL SHIELD AND DRAIN WIRE JACKET: PVC, BLACK (O.D.: .177 [4.5])

WIRE MAP

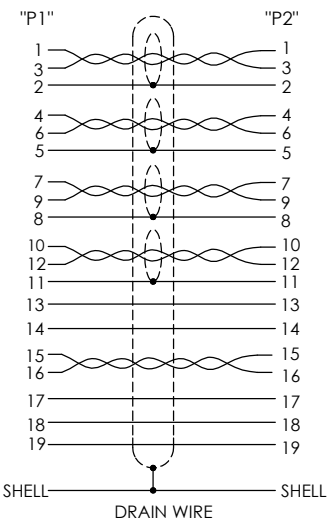

2X HDMI TYPE A MALE CONNECTOR

NOTES:

- CABLE ASSEMBLY SHALL BE TESTED FOR CONTINUITY.
- CABLE ASSEMBLY SHALL BE INDIVIDUALLY PACKAGED IN ACCORDANCE WITH L-COM SPECIFICATION PS-0031.

UNLESS OTHERWISE SPECIFIED, DIMENSIONS ARE IN INCHES [mm] OVERALL CABLE LENGTH TOLERANCE: ≤12 [305] = +1 [25] / -0 >12 [305] ≤60 [1524] = +2 [51] / -0 >60 [1524] ≤120 [3048] = +4 [102] / -0 >120 [3048] ≤300 [7620] = +6 [152] / -0 >300 [7620] = +5% / -0 ALL OTHER DIMENSIONAL TOLERANCES: .X = ±.2 [5]   FRACTIONS ± 1/32 .XX = ±.02 [.5]   ANGLES ± 1° .XXX = ±.005 [.13]	APPROVALS DRAWN BY DFRISIELLO CHECKED BY PHOSPODAR APPROVED BY PHOSPODAR	DATE 10/01/2020 10/01/2020 10/01/2020	50 High Street, West Mill, North Andover, MA 01845 USA. Phone: 1.800.341.5266 1.978.682.6936	
	CONFIGURATION DETAILS OF UNDIMENSIONED FEATURES MAY VARY COLOR VARIATIONS MAY OCCUR	CATEGORY <b>FIBER OPTICS</b>		PRODUCT DESCRIPTION <b>HDMI 2.0 Type A to Type A Active Optical Cable</b>
THIRD-ANGLE PROJECTION 	SIZE <b>A</b>	CAGE CODE <b>43321</b>	ITEM NO. <b>AOC-HDAA-20-010</b>	REV. <b>A</b>
SCALE: NONE		CAD FILE: AOC-HDAA-20-010.SLDDRW		SHEET 1 OF 1