

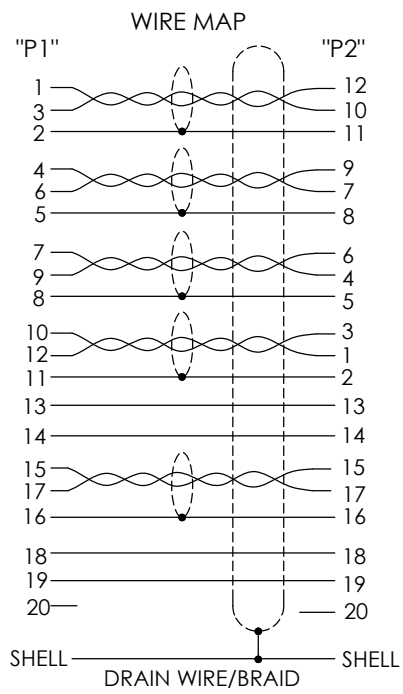

THE INFORMATION CONTAINED IN THIS DRAWING IS THE SOLE PROPERTY OF L-COM, INC. ANY REPRODUCTION IN PART OR WHOLE WITHOUT THE WRITTEN PERMISSION OF L-COM, INC. IS PROHIBITED.

REVISIONS			
REV	DESCRIPTION	DATE	APPROVED
A	INITIAL RELEASE	09/11/2020	PHOSPODAR

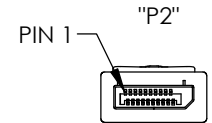
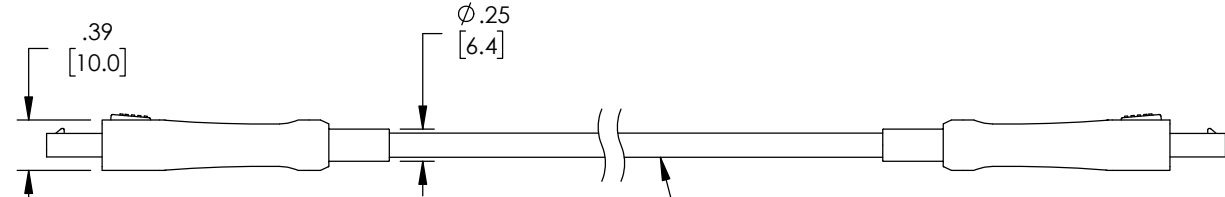
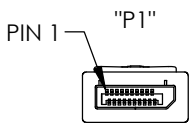
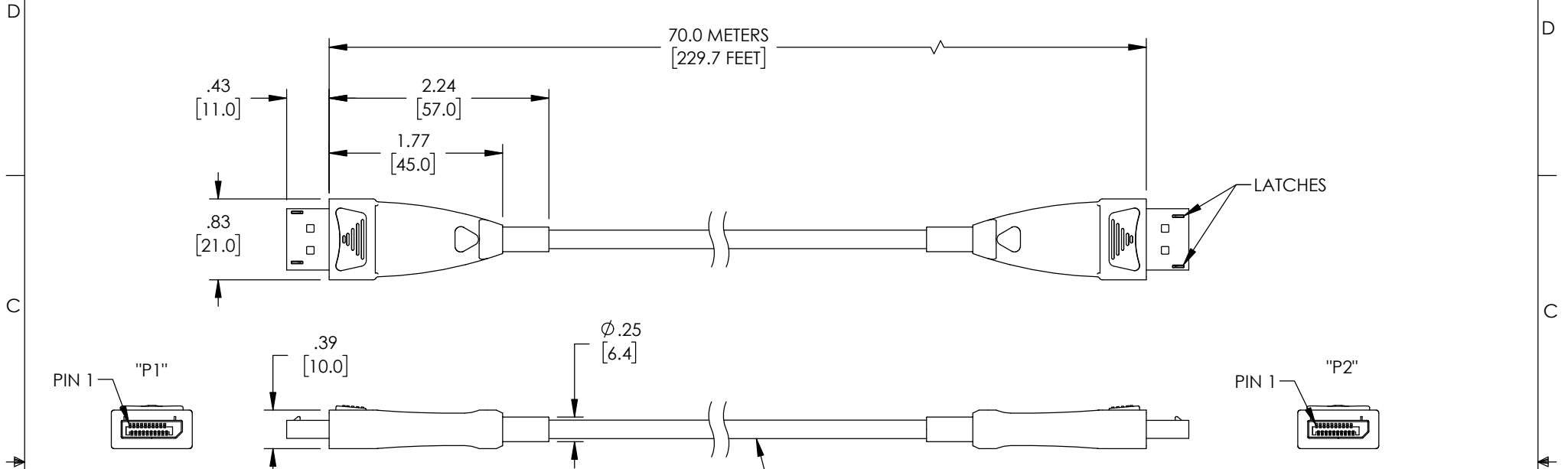

**NOTES:**

1. CONNECTOR DIMENSIONS ARE FOR REFERENCE ONLY.
2. CABLE ASSEMBLY SHALL BE TESTED FOR CONTINUITY.
3. CABLE ASSEMBLY SHALL BE INDIVIDUALLY PACKAGED IN ACCORDANCE WITH L-COM SPECIFICATION PS-0031.

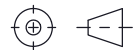
UNLESS OTHERWISE SPECIFIED, DIMENSIONS ARE IN INCHES [mm] OVERALL CABLE LENGTH TOLERANCE: ≤12 [305] = +1 [25] / -0 >12 [305] ≤60 [1524] = +2 [51] / -0 >60 [1524] ≤120 [3048] = +4 [102] / -0 >120 [3048] ≤300 [7620] = +6 [152] / -0 >300 [7620] = +5% / -0 ALL OTHER DIMENSIONAL TOLERANCES: .X = ± .2 [5]   FRACTIONS ± 1/32 .XX = ± .02 [5]   ANGLES ± 1° .XXX = ± .005 [13]	APPROVALS DRAWN BY DFRISIELLO CHECKED BY PHOSPODAR APPROVED BY PHOSPODAR	DATE 09/11/2020 09/11/2020 09/11/2020	 an INFINIT® brand 50 High Street, West Mill, North Andover, MA 01845 USA. Phone: 1.800.341.5266 1.978.682.6936
	CONFIGURATION DETAILS OF UNDIMENSIONED FEATURES MAY VARY COLOR VARIATIONS MAY OCCUR	CATEGORY <b>AUDIO/VIDEO</b>	PRODUCT DESCRIPTION <b>DisplayPort 1.4 to DisplayPort 1.4 Active Optical Cable</b>
THIRD-ANGLE PROJECTION 	SIZE <b>A</b>	CAGE CODE <b>43321</b>	ITEM NO. <b>AOC-DPDP-14-070</b>