

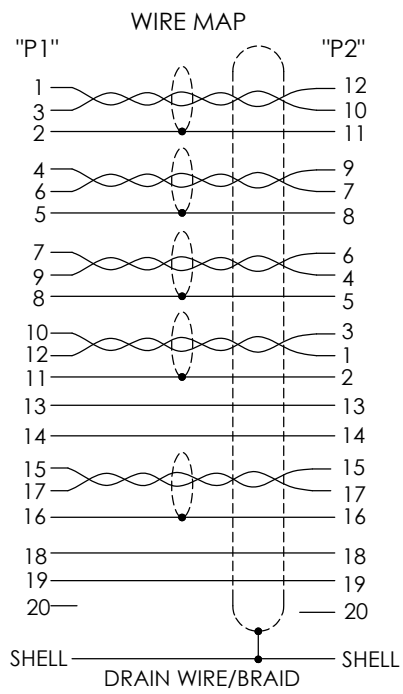

THE INFORMATION CONTAINED IN THIS DRAWING IS THE SOLE PROPERTY OF L-COM, INC. ANY REPRODUCTION IN PART OR WHOLE WITHOUT THE WRITTEN PERMISSION OF L-COM, INC. IS PROHIBITED.

REVISIONS			
REV	DESCRIPTION	DATE	APPROVED
A	INITIAL RELEASE	09/10/2020	PHOSPODAR

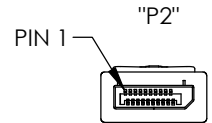
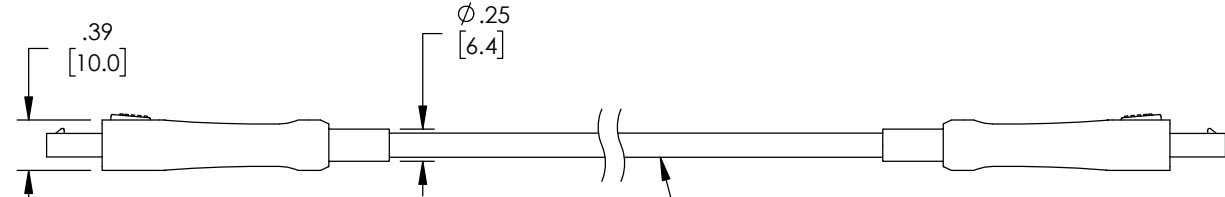
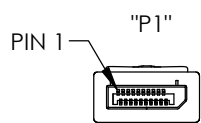
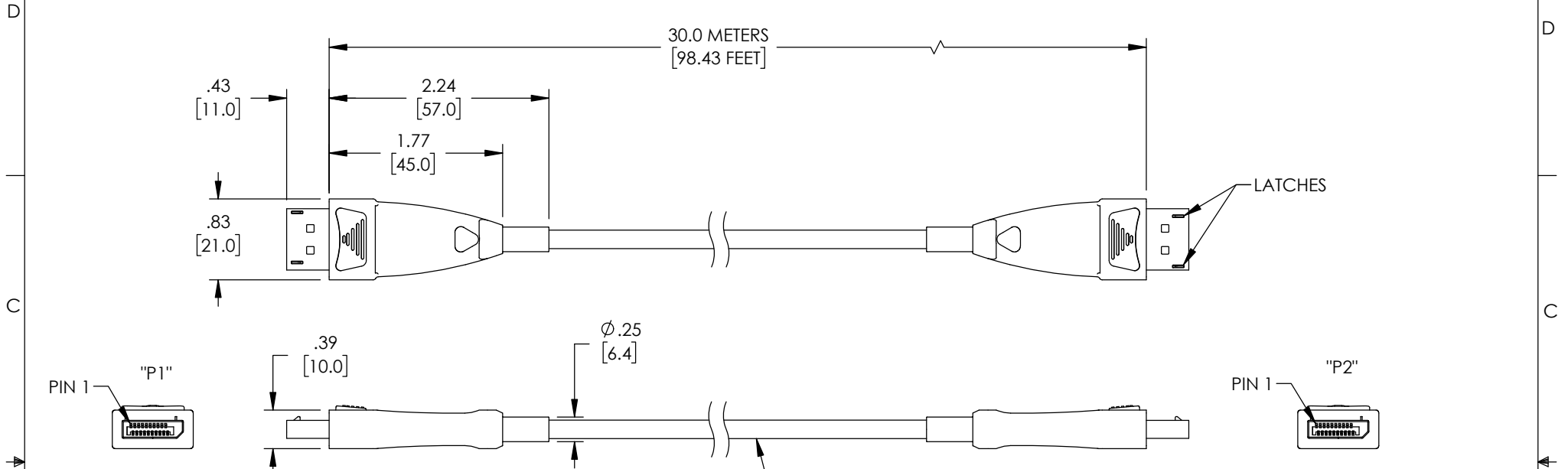

- NOTES:**
- CONNECTOR DIMENSIONS ARE FOR REFERENCE ONLY.
 - CABLE ASSEMBLY SHALL BE TESTED FOR CONTINUITY.
 - CABLE ASSEMBLY SHALL BE INDIVIDUALLY PACKAGED IN ACCORDANCE WITH L-COM SPECIFICATION PS-0031.

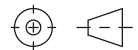
UNLESS OTHERWISE SPECIFIED, DIMENSIONS ARE IN INCHES [mm]	APPROVALS	DATE	 50 High Street, West Mill, North Andover, MA 01845 USA. Phone: 1.800.341.5266 1.978.682.6936
	OVERALL CABLE LENGTH TOLERANCE: ≤12 [305] = +1 [25] / -0 >12 [305] ≤60 [1524] = +2 [51] / -0 >60 [1524] ≤120 [3048] = +4 [102] / -0 >120 [3048] ≤300 [7620] = +6 [152] / -0 >300 [7620] = +5% / -0	DRAWN BY DFRISIELLO	
ALL OTHER DIMENSIONAL TOLERANCES: .X = ± .2 [5] FRACTIONS ± 1/32 .XX = ± .02 [.5] ANGLES ± 1° .XXX = ± .005 [.13]	CHECKED BY PHOSPODAR	09/10/2020	CATEGORY AUDIO/VIDEO
	APPROVED BY PHOSPODAR	09/10/2020	PRODUCT DESCRIPTION DisplayPort 1.4 to DisplayPort 1.4 Active Optical Cable
THIRD-ANGLE PROJECTION 	CONFIGURATION DETAILS OF UNDIMENSIONED FEATURES MAY VARY	COLOR VARIATIONS MAY OCCUR	SIZE A
CAGE CODE 43321		ITEM NO. AOC-DPDP-14-030	REV. A
SCALE: NONE		CAD FILE: AOC-DPDP-14-030.SLDDRW	SHEET 1 OF 1