

Description and operating instructions

line INDUSTRIAL Rail Switch 2

RS2-TX

Bestell-Nr.

943 686-001

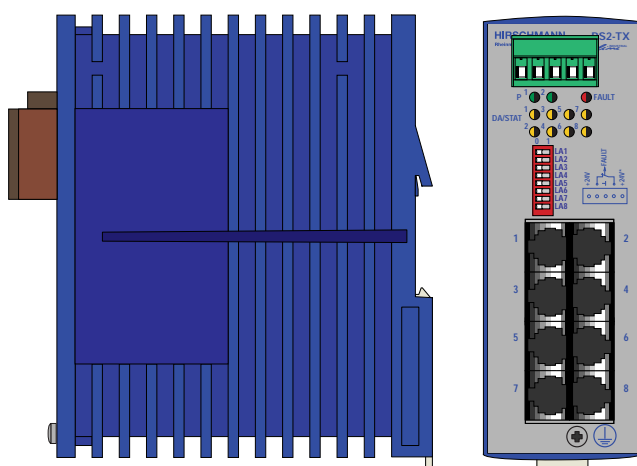

The Rail Switch RS2 has been especially designed for use in industrial environments. It supports ETHERNET 10 MBit/s and Fast ETHERNET 100 MBit/s.

The Rail Switch modules support switched ETHERNET networks in accordance with IEEE standard 802.3 or 802.3u using copper technology. The switch modules are plugged onto the standard bar.

The RS2-TX modules have eight 10/100 MBit/s twisted pair ports (RJ45 connectors).

It is possible to connect up to eight data terminal equipments or other network segments to the 10/100 Mbit/s ports using twisted pair cabling. The ports support auto negotiation and autopolarity.

We have checked that the contents of the technical publication agree with the hardware and software described. However, it is not possible to rule out deviations completely, so we are unable to guarantee complete agreement. However, the details in the technical publication are checked regularly. Any corrections which prove necessary are contained in subsequent editions. We are grateful for suggestions for improvement.

We reserve the right to make technical modifications.

Permission is not given for the circulation or reproduction of this document, its use or the passing on of its contents unless granted expressly. Contravention renders the perpetrator liable for compensation for damages. All rights reserved, in particular in the case of patent grant or registration of a utility or design.

Copyright ©
© Richard Hirschmann GmbH & Co. 1999
All Rights Reserved

General

Electricity is used to operate this equipment. Comply in every detail with the safety requirements specified in the operating instructions regarding the voltages to apply!



Warning!

If warning notes are ignored, it is therefore possible for severe injuries and/or material damage to occur.

Only appropriately qualified staff should work on or near this equipment. Such staff must be thoroughly acquainted with all the warnings and maintenance measures contained in these operating instructions.

The proper and safe operation of this equipment assumes proper transport, appropriate storage and assembly and careful operation and maintenance.

Staff qualification requirements

Qualified staff within the meaning of these operating instructions or the warning notes are persons familiar with setting up, assembling, starting up and operating this product and who have appropriate qualifications to cover their activities, such as:

- training or instruction/entitlement to switch circuits and equipment/systems on and off, earth them and identify them in accordance with current safety standards;
- training or instruction in accordance with current safety standards in looking after and using appropriate safety equipment;
- first aid training.

Safety guidelines



Warning!

The RS2-TX units are designed for operation with safety extra-low voltage. Accordingly, only safety extra-low voltages (SELV) to IEC950/EN60950/VDE0805 may be connected to the supply voltage connections.

ESD protection

The modules contain components highly sensitive to electrostatic fields. These components can be easily destroyed or have their lives shortened by an electrical field or by a discharge caused by touching the card. For these reasons, the modules are delivered in a conducting ESD protective bag. This packing can be reused.

Be sure to observe the following precautions for electrostatic sensitive devices when handling the components:

- Establish electrical potential equality between yourself and your surroundings, e.g. with the aid of a wrist bracelet.
- Only then remove the modules from the conducting bag.
- Store the modules in its conducting bag whenever it is not in the chassis.

ESD protective field kits are available for working with electrostatic sensitive devices.

You can find more information about devices vulnerable to electrostatic fields in DIN/IEC 47 (Sec) 1330; February 1994 Edition and DIN EN 100 015.

1. Functional description

The 10/100BASE-T(X) ports of an RS2-TX represent a terminal connection for the connected LAN segment. You can connect single devices or complete network segments.

1.1 FRAME SWITCHING FUNCTIONS

Store and Forward

All data received by the RS2-TX from the system bus or at the ports are stored and checked for validity. Invalid and defective frames (> 1.522 byte or CRC error) as well as fragments (< 64 byte) are discarded. The RS2-TX forwards the valid frames.

Multi address capability

An RS2-TX learns all source addresses per port. Only packets with
 - unknown addresses
 - addresses learnt at this port
 - a multi/broadcast address
 in the destination address field are sent to this port.

An RS2-TX learns up to 1,000 addresses. This becomes necessary if more than one terminal device is connected to one or more ports. In this way several independent sub-networks can be connected to an RS2-TX.

Learnt addresses

An RS2-TX monitors the age of the learned addresses. The RS2-TX deletes address entries from the address table which exceed a certain age (30 seconds).

Note: Restarting deletes the learned address entries.

Tagging (IEEE 802.1Q)

The IEEE 802.1 Q standard designates the VLAN tag to be included in a MAC data frame for the VLAN and prioritizing functions. The VLAN tag consists of 2 bytes. It is inserted between the source address field and the type field. Data packets with VLAN tag are transmitted unchanged by the RS2-TX.

1.2 SPECIFIC FUNCTIONS OF THE TP/TX INTERFACE

Link control

The RS2-TX monitors the connected TP/TX line segments for short-circuit or interrupt using regular link test pulses in accordance with IEEE standard 802.3 10/100BASE-T/TX. The RS2-TX does not transmit any data to a TP/TX segment from which it does not receive a link test pulse.

Note: A non-occupied interface is assessed as a line interrupt. The TP/TX line to terminal equipment which is switched off is likewise assessed as a line interrupt as the de-energised bus coupler cannot transmit link test pulses.

Auto polarity exchange

If the receive line pair is incorrectly connected (RD+ and RD- switched) polarity is automatically reversed.

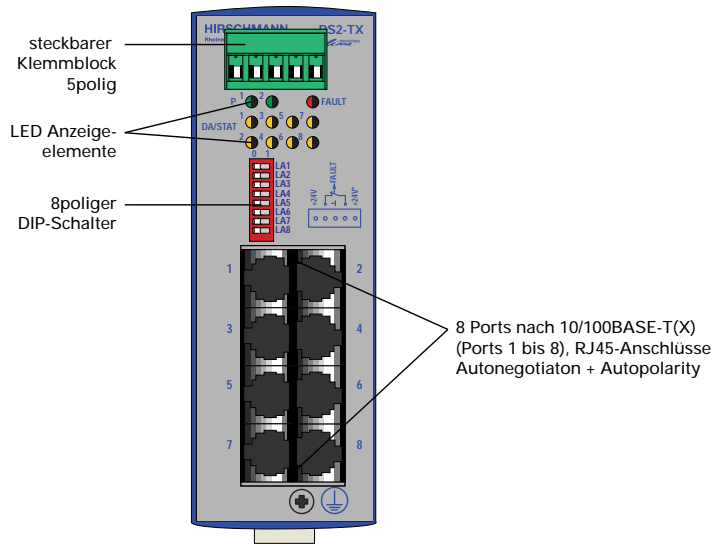

Fig. 1: Overview interfaces, display elements and controls of the RS2-TX

1.3 FURTHER FUNCTIONS AND FEATURES

Reset

The RS2-TX will be reset by the following action:
 - input voltages fall below a threshold

After a reset the following action is carried through:
 - initialization

1.4 DISPLAY ELEMENTS

Equipment status

These LEDs provide information about statuses which affect the function of the entire RS2-TX.

- P1 - Power 1 (green LED)
 - lit: - supply voltage 1 present
 - not lit: - supply voltage 1 less than 9.6 V
- P2 - Power 2 (green LED)
 - lit: - supply voltage 2 present
 - not lit: - supply voltage 2 less than 9.6 V

FAULT - Failure (red LED)

- lit: - The indicator contact is open, i.e. it indicates an error.
- not lit: - The indicator contact is closed, i.e. it does not indicate an error.

Port Status

These LEDs display port-related information.

DA/STAT 1 to 8 - Data, Link status (green/yellow LED)

- not lit: - no valid link
- lit green: - valid link
- flashes yellow:- receiving data

1.5 CONTROLS

8-pin DIP switch

Using the 8-pin DIP switch on the RS2-TX front panel
 - the message about the link statuses can be suppressed by the indicator contact on a port-by-port basis. Using switches LA1 to LA8, the message about the link status

of ports 1 to 8 is suppressed. State on delivery: switch position 1 (on), i.e. message not suppressed.

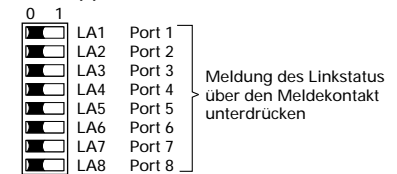

Fig. 2: 8-pin DIP switch on RS2-TX

1.6 INTERFACES

10/100 Mbit/s connection

Eight 10/100 Mbit Ports (ports 1 to port 8, 8-pin R45 sockets) on RS2-TX allow terminal equipment or eight independent network segments complying with the standards IEEE 802.3 100BASE-TX / 10BASE-T to be connected. These ports support autonegotiation and the autopolarity function.

The socket casings are electrically connected to the front panel of the RS2-TX. The pin configuration complies with MDI-X.

- Pin configuration of the RJ45 socket:
 - TD+: pin 3, TD-: pin 6
 - RD+: pin 1, RD-: pin 2
 - remaining pins: not used.

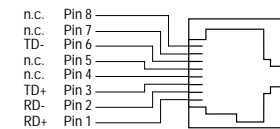

Fig. 3: Pin configuration of an TP/TX interface

5pin terminal block
The supply voltage and the indicator contact are connected via a 5pin terminal block.



Warning!
The RS2-TX equipment is designed for operation with SELV. Only safety extra-low voltages to IEC950/EN60950/VDE0805 may therefore be connected to the supply voltage connections and to the indicator contact.

- Voltage supply: Redundant voltage supplies are supported. Both inputs are decoupled. There is no load distribution. With redundant supply, the power pack supplies the RS2-TX only with the higher output voltage. The supply voltage is electrically isolated from the housing.

- Indicator contact:

The indicator contact is used to supervise the functions of the RS2-TX and thus facilitates remote diagnosis without management software.

Contact interrupt indicates the following by means of a potential-free indicator contact (relay contact, closed circuit):

- the failure of at least one of the two supply voltages.
- a permanent fault in the RS2-TX (internal 3,3 V DC voltage, supply voltage 1 or 2 < 9,6 V, ...).
- the faulty link status of at least one port. The indication of the link state on the RS2-TX can be masked on a port-by-port basis using the DIP switches LA1 to LA8. State of delivery: there is no link test.

Note: In the case of the voltage supply being routed without redundancy, the RS2-TX indicates the failure of a supply voltage. You can prevent this message by feeding in the supply voltage through both inputs.

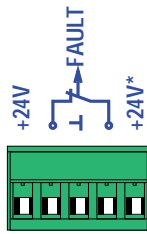

Fig. 5: Pin configuration of 5pin terminal block

Ground connection
The RS2-TX is grounded via a separate screw connection.

2. Configuration

2.1 CONNECTING DTE AND OTHER NETWORK SEGMENTS

It is possible to connect up to eight data terminal equipments (DTE) or other network segments to the 10/100 Mbit/s ports of the RS2-TX using twisted pair cabling (ref. Fig. 4).

3. Assembly, startup procedure and dismantling

3.1 UNPACKING, CHECKING

- Check whether the package was delivered complete (see scope of delivery).
- Check the individual parts for transport damage.



Warning!
Use only undamaged parts!

3.2 ASSEMBLY

The equipment is delivered in a ready-to-operate condition. The following procedure is appropriate for assembly:

- Check whether the switch pre-setting suits your requirements (see chap. 1.5).
- Pull the terminal block off the RS2-TX and wire up the supply voltage and indicator lines.
- Fit the RS2-TX on a 35 mm standard bar to DIN EN 50 022.

- Attach the upper snap-on slide bar of the RS2-TX to the standard bar and press it down until it locks in position.
- Fit the signal lines.

Notes:

- The front panel of the RS2-TX is grounded via a separate ground connection.
- Do not open the housing.
- The shielding ground of the twisted pair lines which can be connected is electrically connected to the front panel.

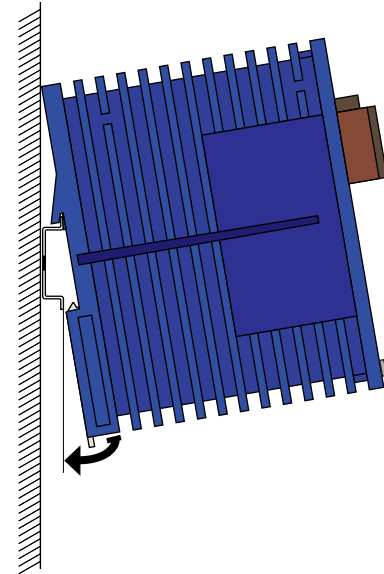

Fig. 6: Assembling the RS2-TX

3.3 STARTUP PROCEDURE

- You start up the RS2-TX by connecting the supply voltage via the 5-pin terminal block.

3.4 DISMANTLING

- To take the RS2-TX off the ISO/DIN rail, insert a screwdriver horizontally under the housing into the locking slide, pull it (without tipping the screwdriver) downwards and lift the RS2-TX upwards.

4. Further support

In the event of technical queries, please talk to the Hirschmann contract partner responsible for looking after your account or directly to the Hirschmann office. You can find the addresses of our contract partners - on the Internet (<http://www.hirschmann.de>).

Our support line is also at your disposal:
Tel. +49(7127) 14-1538 (Fax -1542)

Answers on frequently asked questions you will find in the Internet pages of Hirschmann: www.hirschmann.de. In the Network Systems Division on the SERVICES pages you will find the category FAQ with HiVision.

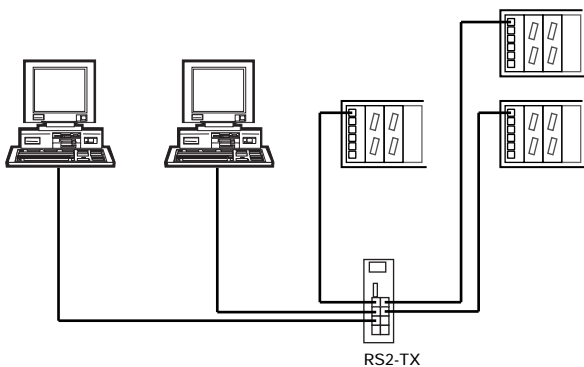

Fig. 4: Configuration with RS2-TX: Connection of up to 8 data terminal equipments or further segments via TP/TX

5. Technical data

General data

Operating voltage	DC 9.6 V...57.6 V safety extra-low voltage (SELV) (redundant inputs decoupled)	
Current consumption	125 mA typ., at 24 VDC, no link 280 mA maximum, at 24 VDC, 8 ports full load	
Overload current protection at input	non-changeable thermal fuse	
Dimensions W x H x D	47 mm x 135 mm x 111 mm	1.9 in x 5.3 in x 4.4 in
Weight	230 g	5.07 lb
Ambient temperature	0 °C to + 60 °C	32 °F to 140 °F
Storage temperature	- 20 °C to + 80 °C	-4 °F to 176 °F
Humidity	up to 90% (non condensing)	
Protection class	IP 20	
Radio interference level	EN 55022 Class A Warning! This is a Class A Equipment. This equipment may cause radio interference if used in a residential area; in this case it is the operator's responsibility to take appropriate measures.	
Interference immunity	EN 50082-2	

Network size

TP/TX port 10BASE-T/100BASE-TX	
Length of a twisted pair segment	100 m (328 ft) maximum

Interfaces

8 TP/TX ports	RJ45 sockets, 10/100 MBit/s
Indicator contact	1 A maximum, 24 V

Displays

Equipment status	1 x green LED	P1 – power 1, supply voltage 1 present
	1 x green LED	P2 – power 2, supply voltage 2 present
	1 x red LED	FAULT – indicator contact is open and indicates error
Port status	8 x green/yellow LED	DAT/STAT 1 to 8 – data, link status

Controls

8-pole DIP switch	LA1 to LA8 – suppress message about the link statuses
-------------------	---

Scope of delivery

Rail Switch RS2-TX incl. terminal block for supply voltage description and operating instructions	
---	--

Order number Rail Switch RS2-TX	943 686-001
------------------------------------	-------------

Accessories

ETHERNET manual	943 320-011
-----------------	-------------



Notes on CE identification
The devices comply with the regulations of the following European directive:

89/336/EEC

Council Directive on the harmonization of the legal regulations of member states on electromagnetic compatibility (amended by Directives 91/263/EEC, 92/31/EEC and 93/68/EEC).

Area used	Requirements for emitted interference	interference immunity
Industrial	EN 50081-2: 1993 EN 55022 Class A: 1998	EN 50082-2: 1995

The EU declaration of conformity is kept available for the responsible authorities in accordance with the above-mentioned EU directives at:

Richard Hirschmann GmbH & Co.
Automation and Networking Solutions
Stuttgarter Straße 45-51
D-72654 Neckartenzlingen
Telephone ++49-7127-14-1538

The product can be used in the residential sphere (residential sphere, business and trade sphere and small companies) and in the industrial sphere.

The precondition for compliance with EMC limit values is strict adherence to the construction guidelines specified in this description and operating instructions.



FCC Note:

This equipment has been tested and found to comply with the limits for a Class A digital device, pursuant to part 15 of the FCC Rules. These limits are designed to provide reasonable protection against harmful interference when the equipment is operated in a commercial environment. This equipment generates, uses, and can radiate radio frequency energy and, if not installed and

used in accordance with the instruction manual, may cause harmful interference to radio communications. Operation of this equipment in a residential area is likely to cause harmful interference in which case the user will be required to correct the interference at his own expense.



Recycling Note:

After its use, this product has to be processed as electronic scrap to a proper disposal according to the prevailing waste disposal regulations of your community / district / country / state.

Richard Hirschmann GmbH & Co.
Automation and Networking Solutions Division
Stuttgarter Str. 45-51
D-72654 Neckartenzlingen
Telephone ++49 - 7127 14 1538



039616001011199000