

Item #	Description	Wiring	1-9	10-24	25-99	100-249
--------	-------------	--------	-----	-------	-------	---------

RoHS Modular Y Adapters - Allow Line Splitting Flexibility in Today's DataCom Networks

Market demand for varied types of modular Y splitter cables has prompted this choice of six standard listings. The most popular types are stocked in one foot overall lengths. However, custom lengths are available. A dark, Gray molded box design style with all rounded edges is used as well as round U.T.P. Category 3 cable. All contact surfaces have 50 microinches gold plating. **Note:** Custom variations solicited to include: choice of modular jacks, any length of cable, different modular or DIN or other style plugs on cable. Minimum quantity of 250 may apply for most custom quotes.

ECS203-1	Modular Y-Bridge, USOC-6 / USOC-6	A	7.95	7.31	6.68	6.04
ECS204-1	Modular Y-Bridge, USOC-8 / USOC-8	B	7.95	7.31	6.68	6.04
ECS205-1	Modular Y-Splitter, 10Base-T / 10Base-T	C	7.95	7.31	6.68	6.04
ECS206-1	Modular Y-Splitter, 10Base-T / Token Ring	D	7.95	7.31	6.68	6.04
ECS207-1	Modular Y-Splitter, Token Ring / Token Ring	E	7.95	7.31	6.68	6.04
ECS208-1	Modular Y-Splitter, Token Ring / Token Ring	F	7.95	7.31	6.68	6.04

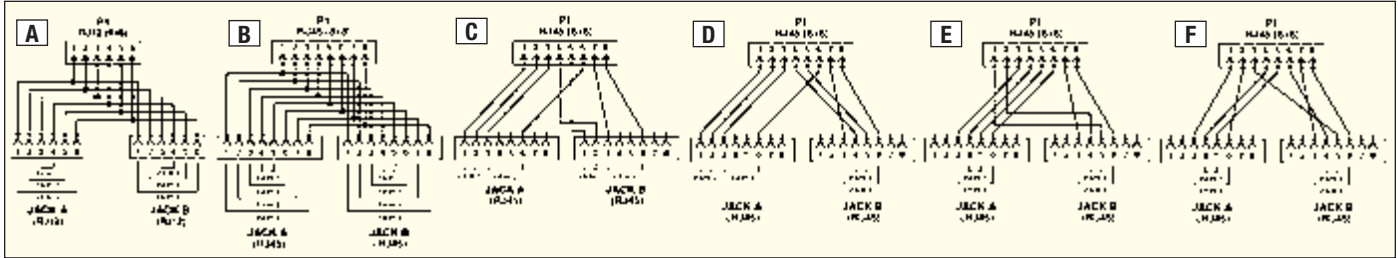
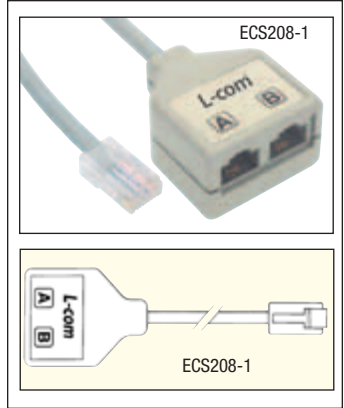

RoHS Shielded Modular 2-Way Splitters - Allow Multiple Uses of 4-Pair Cabling

This series is designed for use in environments where shielding protection is required. Features include: fully shielded PCB mounted jacks, RJ45 plugs with a 360 degree strain relief and a sturdy ABS housing. Three configurations in 12 inch lengths are offered. The bridging adapter combines all like numbered pins allowing devices to share a single interface. Two splitter versions are available configured for 10Base-T and Token Ring applications. Custom configurations will be considered with modest minimums. Please contact our Sales group for assistance.

ECS801-1	USOC Splitter, 8x8 Plug / 2 (8x4) Jacks	A	9.95	9.15	8.36	7.56
ECS802-1	TIA568 Splitter, 8x8 Plug / 2 10Base-T Jacks	B	9.95	9.15	8.36	7.56
ECS803-1	USOC Bridge, 8x8 Plug / 2 (8x8) Jacks	C	9.95	9.15	8.36	7.56

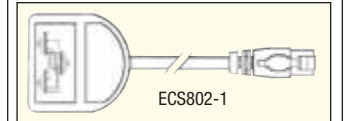
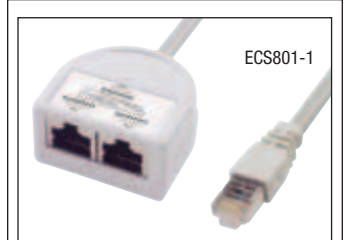
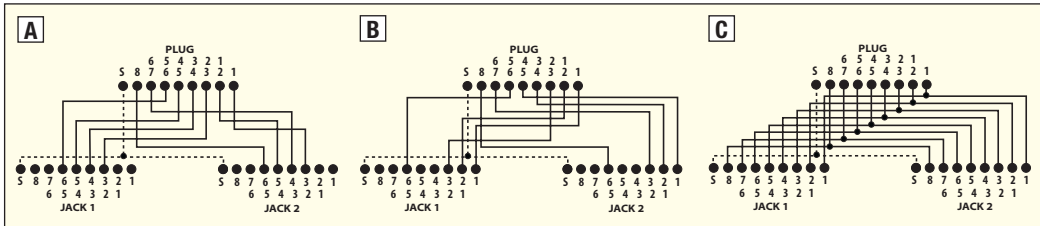

RoHS Modular 4-Way Splitters - Allow Multiple Uses of 4-Pair Cabling

This series allows users to take advantage of installed 4-pair to gain access to individual pairs or bridge multiple jacks. Four configurations in a 12 inch overall length are offered. The bridging adapter combines all like numbered pins allowing devices to share a single interface. The breakout models allow access to each individual pair at the 8x8 plug through four 6x2 or 8x2 jacks. Custom configurations will be considered with modest minimums. Please contact our Sales group for assistance.

ECS401-12	TIA568B Splitter, 8x8 Plug / 4 (6x2) Jacks	A	9.95	9.15	8.36	7.56
ECS402-12	USOC Splitter, 8x8 Plug / 4 (6x2) Jacks	B	9.95	9.15	8.36	7.56
ECS403-12	TIA568 Splitter, 8x8 Plug / 4 (8x2) Jacks	C	9.95	9.15	8.36	7.56
ECS404-12	USOC Bridge, 8x8 Plug / 4 (8x8) Jacks	D	9.95	9.15	8.36	7.56

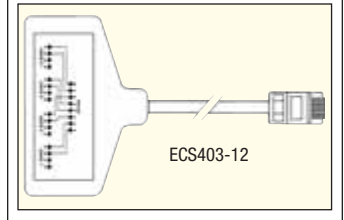
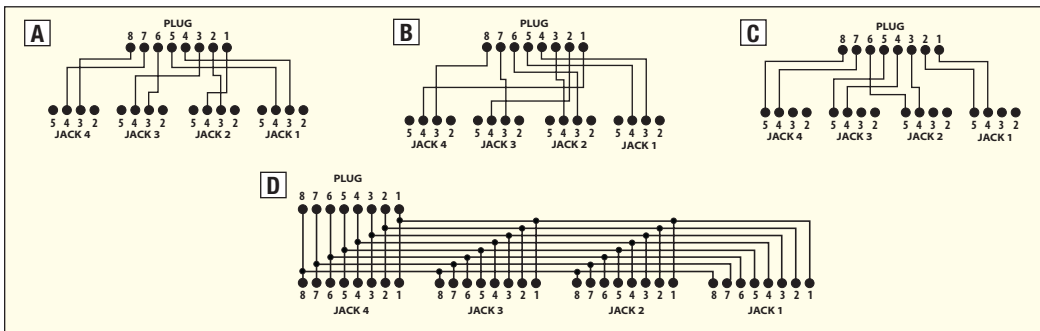

We want to help you!
See a complete list of free tips, tutorials and videos at L-com.com/Resources